



Operation Manual

CONTENTS

Attention	p. 3
Type codes	p. 4
Delivery package	p. 5
Purpose	p. 6
Main technical specifications	p. 6
Operating procedures	p. 7
Electronics operation algorithm	p. 7
Installation and setup	p. 9
Electrical mains connection	p. 12
Technical maintenance	p. 13
Transportation and storage regulations	p. 13
Manufacturer's warranty	p. 13
Figures - external view and dimensions	p. 16
Figures - installation options	p. 21
Figures - fan mounting options relative to walls and ceiling	p. 23
Figures - installation sequence	p. 24
Figures - power mains connection	p. 29
Schematic diagrams of fan connection to power mains	p. 30
Figures - timer and humidity sensor setup	p. 38
Acceptance certificate	p. 39
Warranty card	p. 40

ATTENTION!

Disconnect the product from the power mains prior to all operations specific to connection, setup, maintenance and repair.

Maintenance and installation shall only be performed by the personnel qualified for unassisted operations with electrical installations up to 1000 V familiar with the present specification.

The single-phase mains which the product is to be connected to shall be compliant with the standing regulations.

The stationary wiring shall be equipped with an automatic circuit breaker.

The connection shall be made via QF switch integrated into the stationary wiring.

The contact gap on all poles shall be at least 3 mm.

Prior to installation check for visible damage of the impeller, casing, grill and make sure there are no foreign objects in the fan casing which may damage the impeller blades.

The product may only be used as intended. No modifications or alterations are allowed.

The unit is not intended for operation by children or any persons with reduced physical, mental or sensory capacities, lacking practical experience or knowledge unless not controlled or briefed on the device operation by the person responsible for their safety.

Children must remain under the supervision of adults who must prevent their playing with the device.

Take all the reasonable steps to prevent penetration of smoke, carbon monoxide and other combustion products onto the premises through open fume ducts or other fire extinguishing equipment.

Also take steps to prevent back draft of gas from devices utilizing a gas or direct flame (except KP and KVK models).

The transported air shall not contain any dust and other hard impurities, sticky substances and fibrous materials.

Do not use the product if the handled medium contains inflammable substances or fumes such as alcohol, gasoline, insecticides etc.

Do not close or block the device inlet and outlet so as not to impede optimum air flow.

Do not sit on the device or put any objects on top of it.

The product owner must follow this manual.



Upon service life expiry the product shall be disposed of individually.

Do not dispose of the product with unsorted municipal waste.

TYPE CODES

Fan Designation Key

VN V-1 X 80 X X X

VN - Fan

Forced Draught

V - modification for concealed
(in-the-wall) installation

1 - plastic front panel

2 - aluminium front panel

Air Flow Rate, m³/h:

Unmarked - 60/100/150;

A - 35/60;

B - 35/100;

C - 35/60/100;

D - 60/100.

80 - outlet diameter in mm

Extra Options:

I - interval switch;

F - Photoelectric sensor;

H - Timer with humidity sensor;

T - Timer;

TP - Adjustable timer.

Casing Type:

Unmarked - external plastic casing;

K - external plastic casing with a fire damper;

KV - in-the-wall, plastic casing;

KP - in-the-wall, fire-preventing casing;

KVK - in-the-wall, plastic casing with a fire damper;

XXX-D - with a supplementary bottom spigot*;

XXX-L - with a supplementary left-side spigot*;

XXX-P - with a supplementary right-side spigot*.

* - with the outlet on top

XXX - KV, KP or KVK.

Sample designation:

VN-1 A 80 H - High Pressure Fan with a plastic front panel, air flow rate 35/60 m³/h, outlet diameter 80 mm, equipped with a humidity sensor.

Conventional Designations of Casings

XXX-X 80

Casing Type:

KV - in-the-wall, plastic casing;

KP - in-the-wall, fire-preventing casing;

KVK - in-the-wall, plastic casing
with a fire damper;

Outlet Fitting Diameter, mm

Position of supplementary inlet fitting for ventilating one more room:

Unmarked - no supplementary inlet;

D - bottom inlet*;

L - left-side inlet*;

P - right-side inlet*.

* - with the outlet on top

XXX - KV, KP or KVK.

	VN 80(K)/ VN-1 80 K	VNV-1 80 KV/ VNV-1 80 KP/ VNV-1 80 KVK	VNV-1 80	KV 80/ KP 80/ KVK 80
Fan System (complete), pcs	1	1		
Fan Assembly, pcs			1	
Casing, pcs.				1
Set of Fasteners, pcs.	1	1	1	1
Mounting Bracket, pcs.		2		
Protective fiberboard plate, pcs.				1
Plastic screwdriver, pcs (only for timer-equipped models)	1	1	1	
Operation Manual, pcs	1	1	1	1
Packing Box, pcs.	1	1	1	1

**DELIVERY
PACKAGE**

PURPOSE

The product is a centrifugal fan for exhaust ventilation of small and medium accommodation spaces heated in the winter season.

The fan can be mounted on the ceiling or on a wall with the air exhaust directed into a ventilation shaft or a round duct of suitable diameter.

Each fan model is designed for a specific installation type:

VENTS VN 80 (K) / VENTS VN-1 80 (K) - wall surface mounting;

VENTS VNV-1 80 KV / KP / KVK - concealed (intrasystem) installation;

VENTS VNV-1 80 - fan assembly designed for installation into a pre-mounted casing of **KV 80, KP 80** or **KVK 80**.

VENTS VNV-1 80 KP, VENTS VNV-1 80 KVK, VENTS VN-1 80 K and **VENTS VN 80 K** models comply with special fire safety requirements and are designed to protect the premises against smoke fumes which may penetrate through the air ducts in case of a fire.

**MAIN
TECHNICAL
SPECIFICATIONS**

The figures 1 through 11 show the outside and connection dimensions of the products. The main parameters are given in Table 1.

	Basic Model	A	B	C	Table 1. D
Number of Speeds	3	2	2	3	2
Voltage, V (50 Hz)	220-240				
Power Consumption, W	17/27/48	12/17	12/27	12/17/27	17/27
Current, A	0,14/0,18/0,21	0,12/0,14	0,12/0,18	0,12/0,14/0,18	0,14/0,18
Maximum Air Flow, m ³ /h	63/102/150	35/63	35/102	35/63/102	63/102
Rotation Speed, rpm	1350/1830/2640	890/1350	890/1830	890/1350/1830	1350/1830
Sound Pressure Level at 3 m, dB(A)	30/35,2/43,7	26,6/30	26,6/35,2	26,6/30/35,2	30/35,2
Maximum Transported Air Temperature, °C	50				

The fan is intended for connection to a 220...240 V 50 Hz AC Mains and allows continuous operation without disconnection from the power mains.

The fans are suitable for operation at ambient temperatures ranging from +1°C to +45°C. The fan must be grounded.

Protection Class - IP55.

Basic Models:

Two- and Three-Speed Fans.

The speed is set using an external speed selector.

Note: Options T, TR, I, F and H are available with two-speed fans only.

T - with a timer:

Depending on the connection pattern the fan remains off or constantly operates at speed 1. When turned on with an external switch the fan switches to speed 2 after 50 second delay. Following turning-off the fan continues running at speed 2 for 6 minutes and then reverts to the initial state automatically.

TR - with an adjustable timer:

Depending on the connection pattern the fan remains off or constantly operates at speed 1. Following activation with an external switch and on elapsing of the timer delay which can be set within the range from 0 to 150 seconds the fan switches to speed 2. Following turning-off the fan continues at speed 2 for an interval from 2 to 30 minutes and then reverts to the initial state automatically. The fan operation duration and speed 2 turn-on delay are set by the built-in regulator.

**OPERATING
PROCEDURES**

**ELECTRONICS
OPERATION
ALGORITHM**

I - with an interval switch:

Depending on the connection pattern the fan remains off or constantly operates at speed 1. From time to time as set by the user (from 30 minutes to 15 hours) the fan switches to maximum speed to operate for 10 minutes and then reverts to the initial state. On external switch actuation the fan switches to maximum speed after 50 seconds. On external switch tripping the fan reverts to the interval operation mode.

F - with an integral photoelectric sensor:

Depending on the connection pattern the fan remains off or constantly operates at speed 1. When the lights are switched on the fan switches to the maximum speed in 50 seconds. When the lights are switched off the fan continues at speed 2 for a period from 2 to 3 minutes and then revert to the initial state. The duration of fan operation at speed 2 is controlled by the built-in regulator.

H - with a humidity sensor:

Depending on the connection pattern the fan is off or constantly operates at speed 1. The fan switches to speed 2 on with an increase of relative humidity level on the premises. The sensor operating threshold can be set from 60% to 90%. The unit switches off on relative humidity dropping 10% below the pre-set level. The fan can be manually set to speed 2 on light switch actuation. In this case the actuation delay is 50 seconds whereas the operating interval is controlled by the built-in regulator within the range from 2 to 30 minutes.

ATTENTION!

The electronic circuit board is under mains voltage.

Make sure to disconnect the fan from the power mains prior to any adjustments.

The fan Delivery Package includes a special plastic screwdriver for adjusting the fan settings.

Use this tool to change the timer delay or humidity level settings (Fig. 79).

Using a metal screwdriver or a knife for adjustment may cause a circuit board failure.

To adjust the timer delay turn the knob of potentiometer T (T1) clockwise to increase the value or counterclockwise to decrease it (Fig. 76-78);

To adjust the humidity threshold setting turn the knob of potentiometer C clockwise to increase the value or counterclockwise to decrease it (Fig. 78).

The fan can be mounted on the ceiling or on a wall with the air exhaust directed into a ventilation shaft or a round duct of suitable diameter.

Examples of fan installations are given on Fig. 12-22.

Examples of in-the-wall fan mounting with a supplementary inlet fitting are given on Fig. 23-24.

INSTALLATION AND SETUP

To install fan VN-1 80:

- 1.1. Mark and drill a hole for the outlet fitting following one of the 4 installation options (Fig. 25-28);
- 1.2. Remove the front panel (Fig. 29);
- 1.3. Remove the filter (Fig. 30);
- 1.4. Remove the screw and the grill (Fig. 31);
- 1.5.. Install the fan casing as shown (Fig.. 25-28), mark the holes for self-tapping screws (Fig. 32);
- 1.6. Drill dowel holes and install the dowels (Fig. 33);
- 1.7. Install the fan casing and scroll assembly and secure it with self-tapping screws (Fig. 34);
- 1.8. Perform operations 1.2.-1.4. in the reverse order.

To install VN 80 fan:

- 2.1. Mark and drill a hole for the outlet fitting following one of the 4 installation options (Fig. 25-28);
- 2.2. Remove the decorative blind (Fig. 35);
- 2.3. Remove the front panel retention screw (Fig. 36);
- 2.4. Remove the front panel (Fig. 37);
- 2.5. Perform operations 1.6.-1.7.;
- 2.6. Perform operations 1.2.-1.4. in the reverse order.

To install VN-1 80 K fan:

- 3.1. Mark and drill a hole for the outlet fitting following one of the 3 installation options (fig. 25-27);
- 3.2. Perform operations 1.2.-1.4.;
- 3.3. Set the hinged fire damper to the mounting position (Fig. 38);
- 3.4. Mark dowel hole centers (Fig. 39);
- 3.5. Drill dowel holes and install the dowels (Fig. 40);
- 3.6. Secure the hinged fire damper with self-tapping screws (Fig. 41);

- 3.7. Turn the fan and align the mounting holes in the casing and in the hinged fire damper then mark dowel hole centers (Fig. 42);
- 3.8. Move the fan aside to access the markings, drill dowel holes and install the dowels (Fig. 43);
- 3.9. Turn the fan and align the mounting holes in the casing and in the hinged fire damper, then secure the fan with self-tapping screws (Fig. 44);
- 3.10. Perform operations 1.2.-1.4. in the reverse order.

To install VN 80 K fan:

- 4.1. Perform operation 3.1;
- 4.2. Perform operations 2.2-2.4;
- 4.3. Perform operations 2.2-2.4;
- 4.4. Perform operations 2.2-2.4 in the reverse order.

Fans VN-1 80 KV, VN-1 80 KK and VN-1 80 KP contain fan assembly VN-1 80 and fan casing KV 80, KK 80 and KP 80, respectively. These fans are installed in two stages - i.e. the casing installation is followed by the final assembly: The casing is installed at the structural works stage. The final assembly follows the interior finishing and includes installation of VN-1 80 fan assembly into KV 80, KK 80 or KP 80 casing.

To install KV 80 and KK 80 casing:

- 5.1. Perform operations 1.2.-1.4.;
- 5.2. Remove the fan assembly from the casing (Fig. 48-49);
- 5.3. Bend the mounting bracket to the necessary length as required to fit and secure the bracket to the fan casing with M 4 screws included in the Delivery Package (Fig. 50-53);
- 5.4. Route the power cable into the fan casing;
- 5.5. Fill the gaps between the fan casing the the wall opening with a cement grout, sealing foam etc.
- 5.6. Following the installation cover the casing with the protective fiberboard plate to prevent damage or accumulation of dirt on the casing during the interior finishing of premises (Fig. 54).

To install KP 80 casing:

- 6.1. Perform operations 5.1 and 5.2;
- 6.2. Arrange a recess in the shaft wall for the fan casing (Fig. 21);
- 6.3. Connect an air duct to the fan outlet fitting;
- 6.4. Prior to casing installation make sure that the fire-retarding spring-loaded back valve in KP 80 casing to be installed into the recess closes under spring action at zero air pressure.
- 6.5. Mount KP 80 casing into the construction opening on cement grout.
Route the power cable through the sealed lead-in in the rear part of the casing.
The minimum cable length from the casing is 250 mm. (Fig. 64).
The casing can be also installed inside a wall or in the counterceiling recess using mounting brackets (Fig. 22).
- 6.6. Following the installation cover the casing with the protective fiberboard plate to prevent damage or accumulation of dirt on the casing during the interior finishing of premises (Fig. 54).

To perform final assembly of VNV-1 80 KV, VNV-1 80 KVK and VNV-1 80 KP fans:

- 7.1 On completion of interior finishing remove the protective plate and install VNV-1 80 fan assembly (Fig. 60-61).

The grill design allows its adjustment relative to the casing while mounting the fan to compensate for any misalignment (Fig. 62).

If KV 80, KVK 80 or KP 80 casings and VNV-1 80 fan assembly are supplied separately the fan disassembly during installation is not required.

The remaining installation sequence remains unchanged.

**ATTENTION**

Prior to mounting the fan check the position of back valve 2 which should close under its own weight at zero air pressure (Fig. 63).

By default the back valve position matches the outlet fitting orientation to the right or upwards.

If the outlet fitting is faced left during the fan installation remove the back valve from fitting 1, rotate the valve 180° and reinstall it into the fitting.

**ATTENTION**

For modular air ducts use rectangular-section steel pipes or SPIROVENT spiral-wound ducts. Use flexible ALUVENT or THERMOVENT ducts for joining air ducts.

The nominal diameter of joining air ducts is 80 mm.

**ATTENTION**

If the joining air duct is mounted inside a brick wall it should be wrapped into PVC self-adhesive tape to protect against corrosion or cement grout.

**ELECTRICAL
MAINS
CONNECTION**

Installation examples and various fan connection options are given on Fig. 65...71 and on schematic diagrams 1-12.

To connect the fan to the power mains:

Route the cables through the sealed lead-in in the rear part of the casing;

Strip 7-8 mm of cable ends of insulation, insert them into the corresponding terminals to the insulation and secure with screws (Fig. 64);

Secure the cables with the retaining clip (Fig. 64);

Assemble the fan: reinstall the cover, filter etc.;

Apply power voltage to the fan (Fig. 75).

The technical maintenance includes periodic filter replacement and cleaning of surfaces from accumulations of dust and dirt.

The impeller wheels require thorough cleaning every 6 months.

The filter must be replaced when dirty, but at least once every 6 months.

To replace the filter:

Disconnect the fan from the power mains (Fig. 72);

Remove the filter by following steps 1.2-1.3 or 2.2.-2.4. listed in the Fan Installation section;

Replace the filter and then reverse the installation steps to re-assemble the unit.

Connect the fan to the mains (Fig. 75).

To clean the fan surfaces from dust and dirt:

Disconnect the fan from the power mains (Fig. 72);

Remove the cover by performing operations 1.2.-1.3. or 2.2.-2.4. as listed in the Fan Installation section;

Remove the scroll fastening screws, depress the latches and remove the scroll (Fig. 73);

Rotate the scroll 180° to access the turbine and remove the dust using a soft brush or compressed air stream (Fig. 74);

Re-assemble the fan in the reverse order and connect it to the power mains (Fig. 75).

The unit can be carried in the original packing by any mode of transport without limitation.

The unit must be stored in the original packing at ambient air temperatures from +5 °C to +40 °C at relative air humidity not more than 80%.

The storage premises must be free from dust and corrosive acid or alkaline vapours.

The fan is manufactured at the production facility of Private Joint-Stock Company "Ventilation Systems" (hereinafter "Manufacturer").

By purchasing the product the buyer accepts the terms and regulations specific to operation, storage, transportation, installation, setup, connection, maintenance, repair and warranty coverage of the unit as listed in the accompanying documents provided by the Manufacturer.

**TECHNICAL
MAINTENANCE**

**TRANSPORTATION
AND STORAGE
REGULATIONS**

**MANUFACTURER'S
WARRANTY**

The manufacturer hereby warrants normal operation (service life) of the fan over the period of 60 months from the retail sale date provided observance of the transportation, storage, installation and operation regulations.

Should any malfunctions occur in the fan operation through the Manufacturer's fault during the guaranteed period of operation (service life) the user is entitled to elimination of faults by means of warranty service offered free of charge.

The warranty service includes work specific to elimination of faults in the product operation to ensure its intended use by the user.

The faults are eliminated by replacement or repair of the complete unit or its faulty part (component).

ATTENTION!

Warranty service is offered only to the holders of the original User's Operation Manual or any of its substitutes and the payment document certifying the purchase with a statement of purchase date.

The product model must comply with the one stated in the User's Operation Manual or its substitute.

To benefit from warranty service please contact your retailer.

If the warranty service may not be provided at the office you have contacted you will be referred to an alternative provider.

The manufacturer's warranty does not apply in the following cases:

Customer's failure to submit the product complete with all the parts and accessories listed in the User's Operation Manual or its substitute including any of its components dismounted by the user; Non-compliance of the product model and brand with the information stated on the product packing and in the User's Operation Manual or its substitute;

User's failure to perform technical maintenance in due time (evidenced by dirt, dust, condensed oil or particulate matter);

External damage caused by the user (excluding external modifications of the product as required for installation);

Alteration of product design or engineering changes of the product;

Replacement and use of product assemblies, parts and components not intended by the Manufacturer;

Product misuse;

Violation of the product operation regulations;

Connection to the power mains with voltage in excess of the figures given in the User's Operation Manual;
Voltage surges in the power mains resulting in product failure;
Product repair by the user;
Product repair by a third party without Manufacturer's permission;
Expiration of the product warranty term (service life);
Violation of the prescribed product transportation regulations which prevent product damage, spoilage and/or destruction by the Customer;
Violation of product storage regulations by the Customer;
Wrongful acts against the product committed by third persons;
Circumstances of insuperable force (i.e. fire, flood, earthquake, hostilities of any kind, siege);
Absence of seals if such are provided by the User's Operation Manual or its substitute;
Missing warranty card;
Missing payment document certifying the purchase with a statement of purchase date.

The Manufacturer shall be liable only for the defects which have arisen through its fault prior to product delivery to the user.

However, the Manufacturer shall not be liable for any defects which have arisen following the product delivery to the user and have resulted from violation of product transportation, storage, installation and operation regulation by the user, any acts of third parties, accident or circumstance of insuperable force.

The manufacturer shall not be liable for any injuries of individuals and damage of their property resulting from violation of the User's Operation Manual or its substitute by the user due to misuse or failure to follow any warnings or any other information contained in the User's Operation Manual or its substitute by the user, or any violation of product transportation, storage, installation, technical maintenance and operation regulations by the user.

VN 80

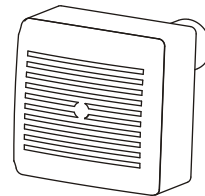
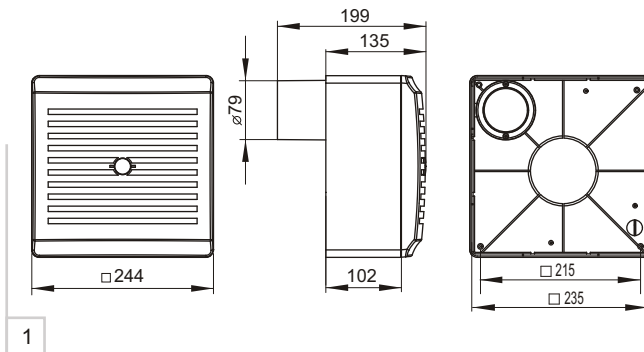

VN-1 80

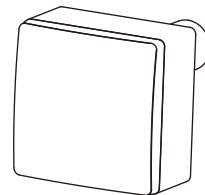
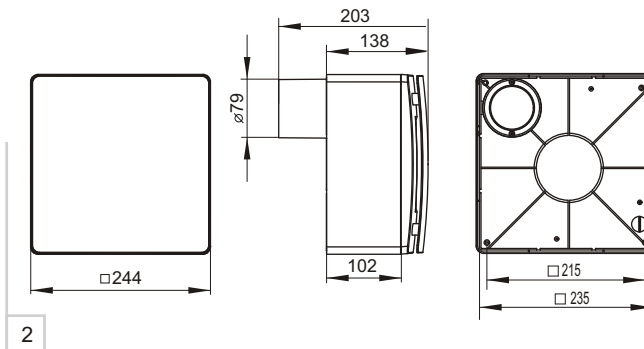

VN 80 K

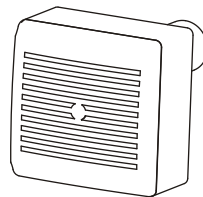
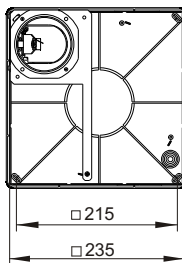
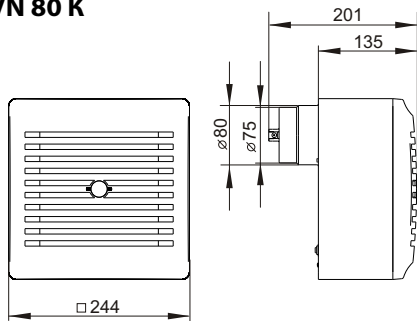

3

VN-1 80 K

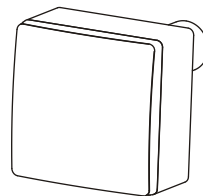
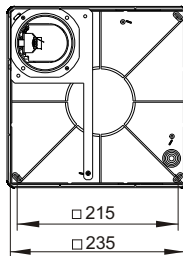
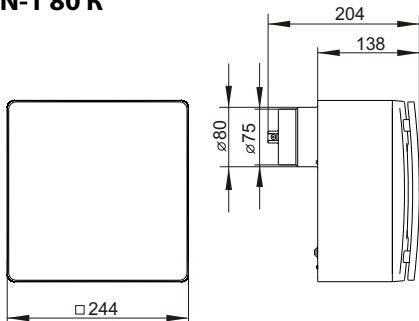

4

VNV-1 80 KV

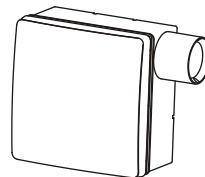
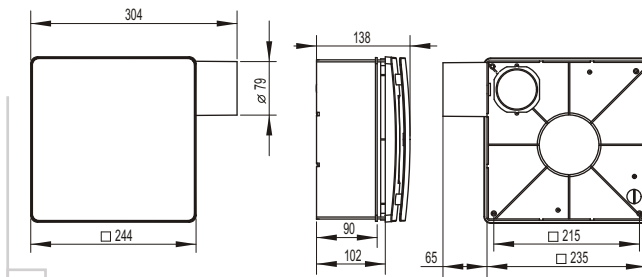

5

VNV-1 80 KP

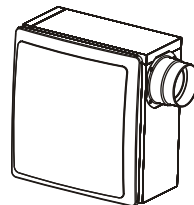
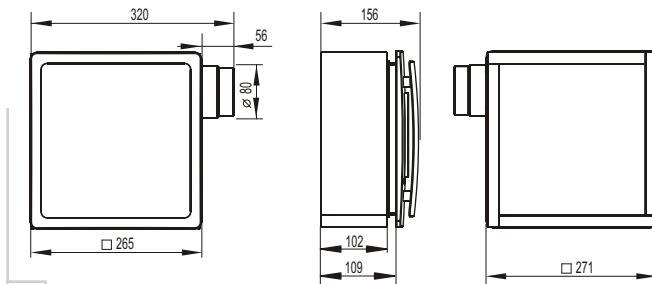

6

VNV-1 80 KVK

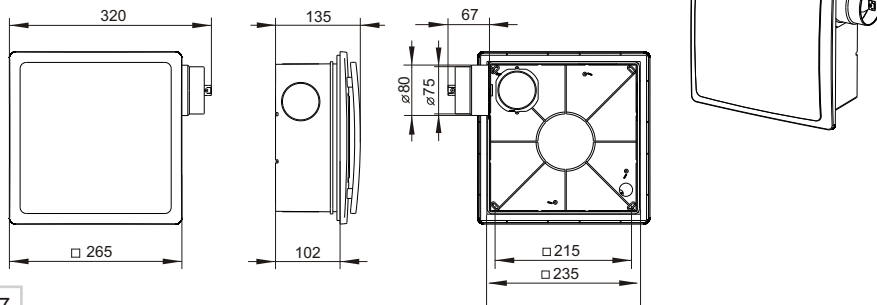

7

VNV-1 80

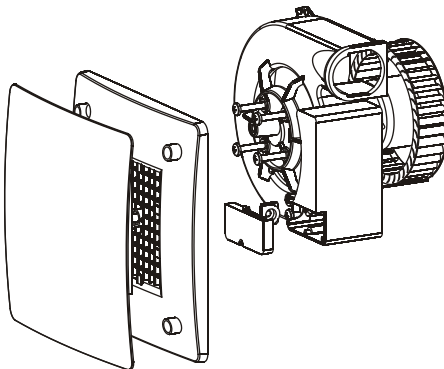

8

KP 80

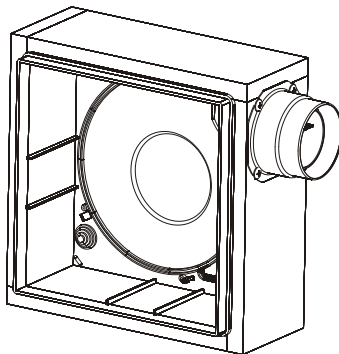

9

KV 80

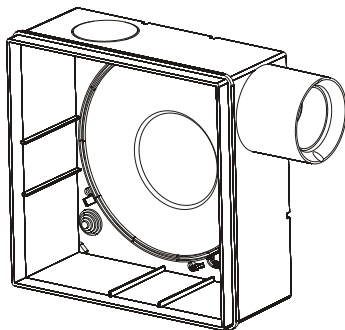

10

KVK 80

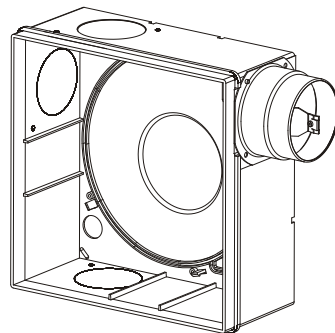

11

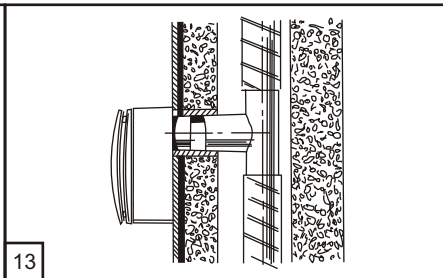
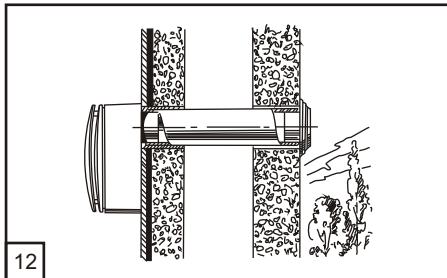

**INSTALLATION
EXAMPLES**
VN 80, VN-1 80
VN 80 K, VN-1 80 K

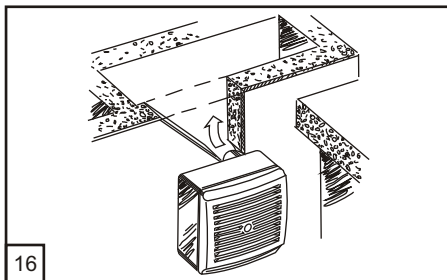
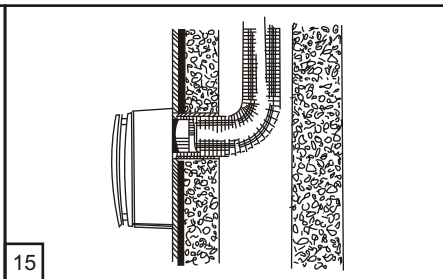
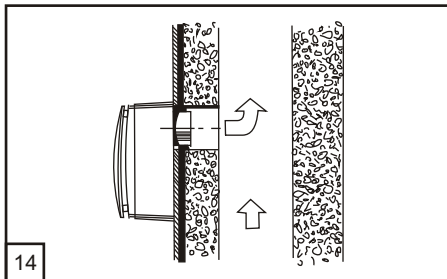

**INSTALLATION
EXAMPLES
VNV-1 80 KV,
VNV-1 80 KVK**

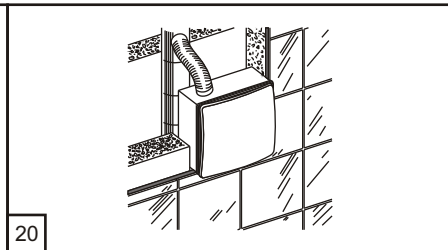
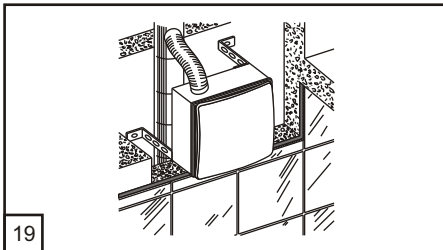
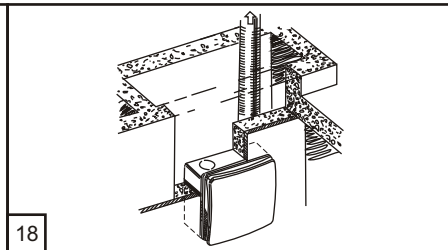
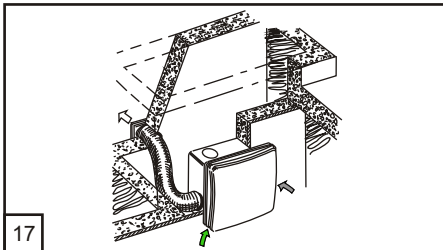

**INSTALLATION
EXAMPLES
VNV-1 80 KP**

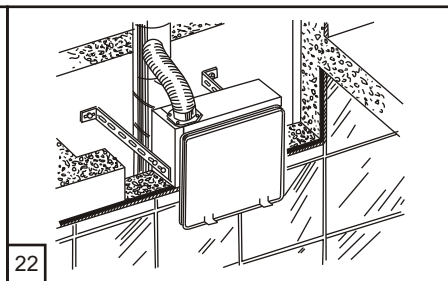
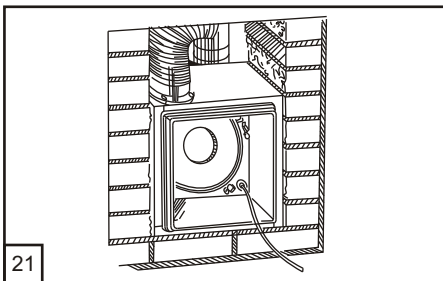

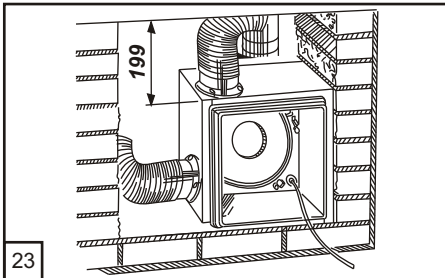

23

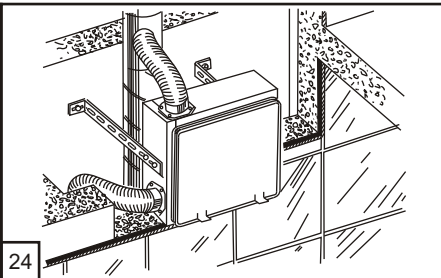

24

**INSTALLATION
EXAMPLES FOR
FANS WITH
SUPPLEMENTARY
INLET FITTING**

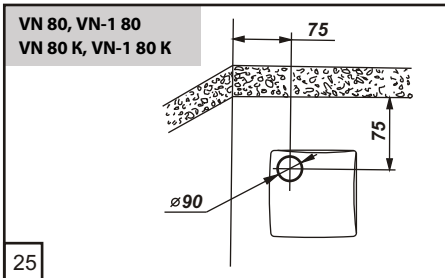

25

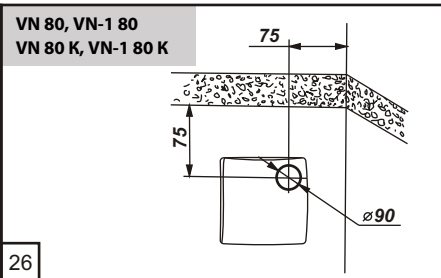

26

**FAN MOUNTING
EXAMPLES
RELATIVE TO
WALLS AND CEILING**

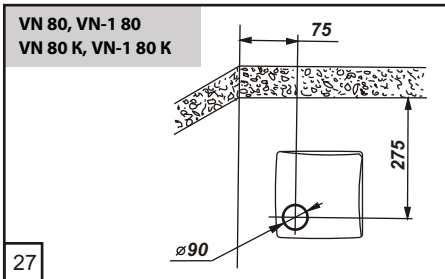

27

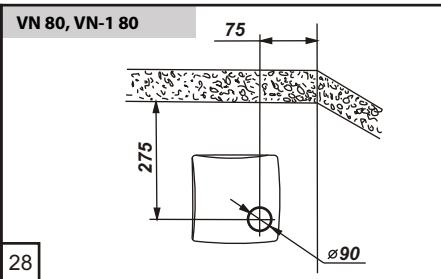

28

**VN-1 80
INSTALLATION
PROCEDURE**

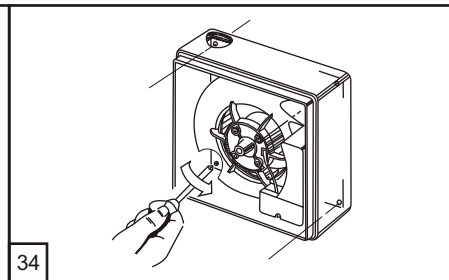
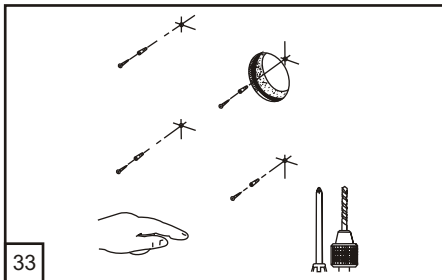
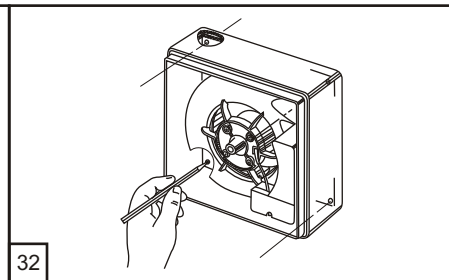
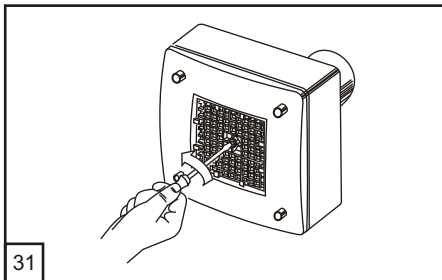
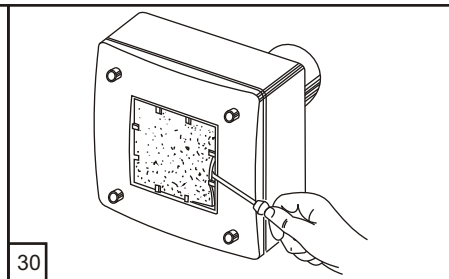
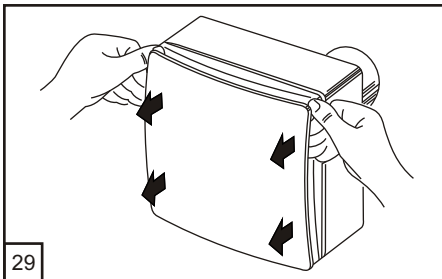

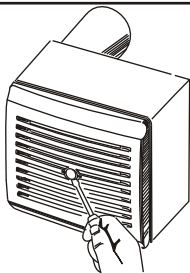

35

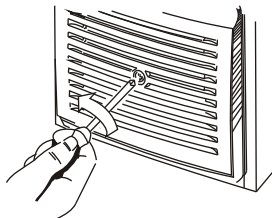

36

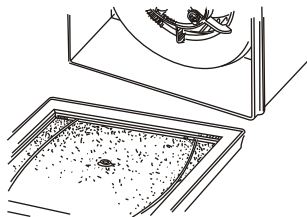
**VN-80
INSTALLATION
PROCEDURE**

37

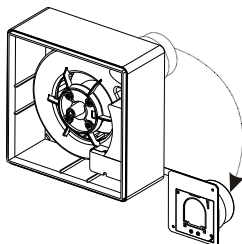

38

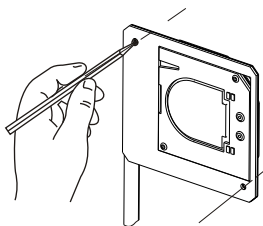

39

**VN-1 80 K
INSTALLATION
PROCEDURE**

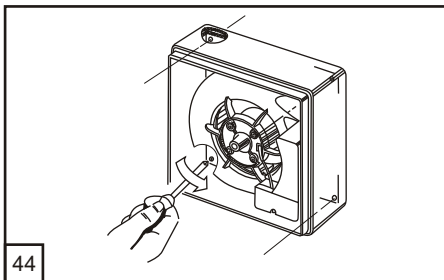
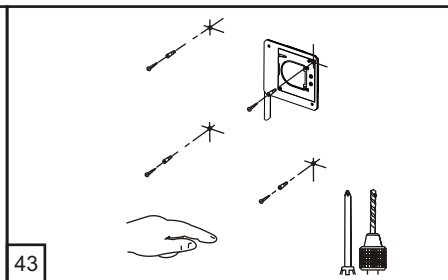
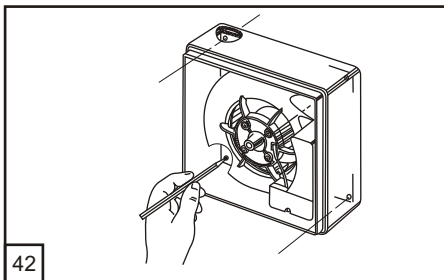
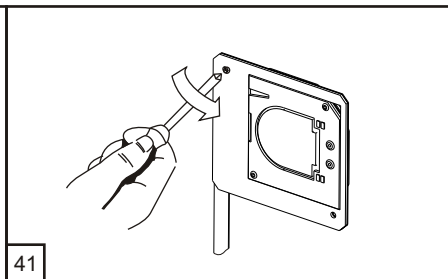
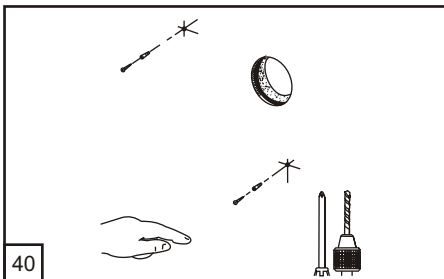

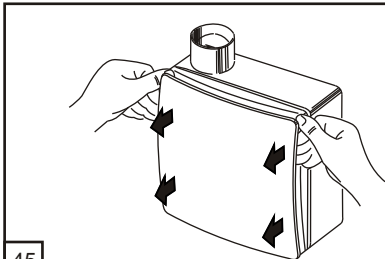

45

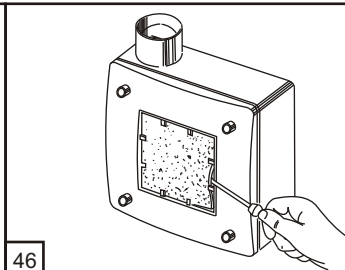

46

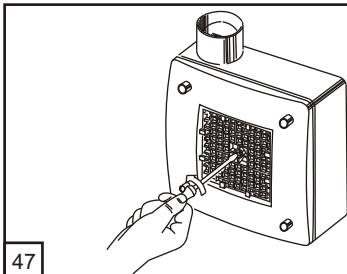

47

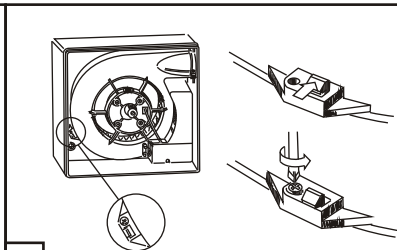

48

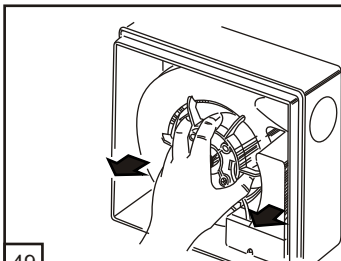

49

VNV-1 80 KV
VNV-1 80 KVK
VNV-1 80 KP
INSTALLATION
PROCEDURE

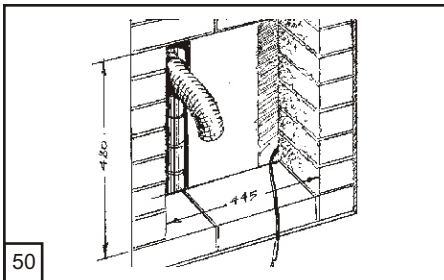

50

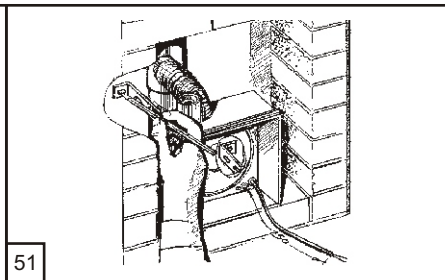

51

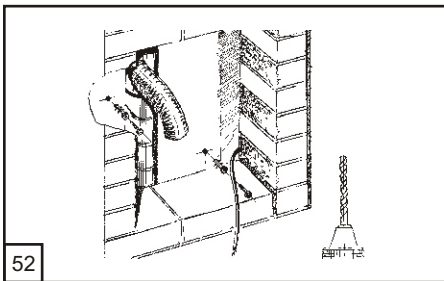

52

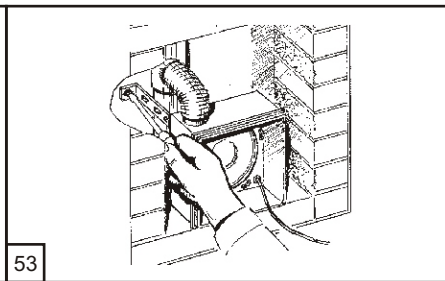

53

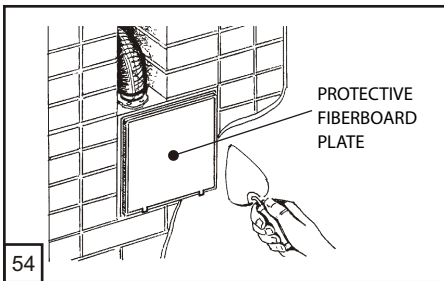

54

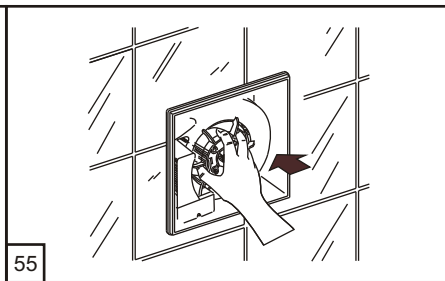

55

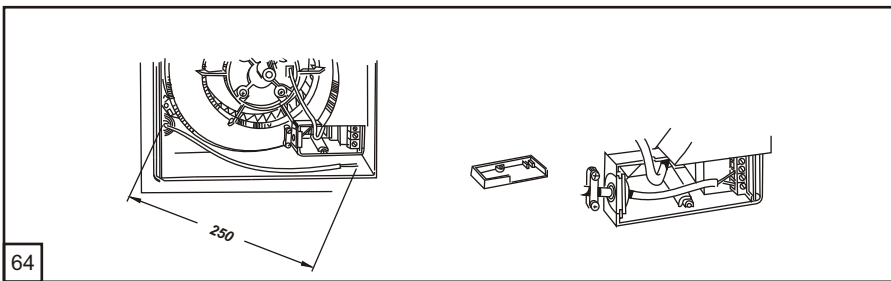
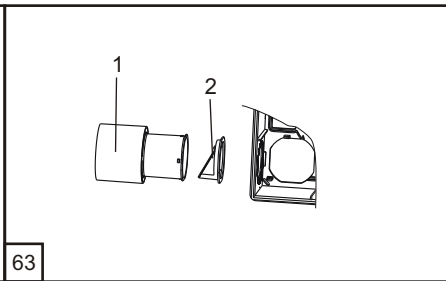
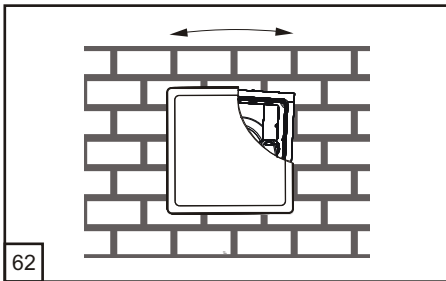
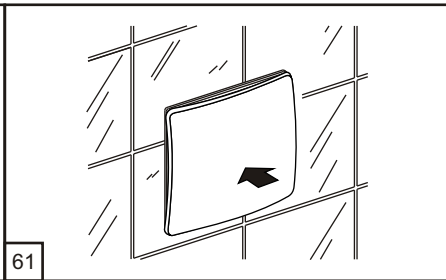
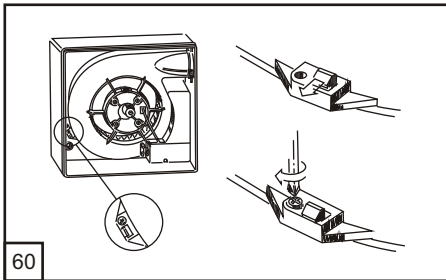

**ELECTRICAL
MAINS
CONNECTION**

**FAN CONNECTION
TO POWER MAINS
SCHEMATICS**

Sample schematic of basic three-speed fan model connection - basic modification and modification C.

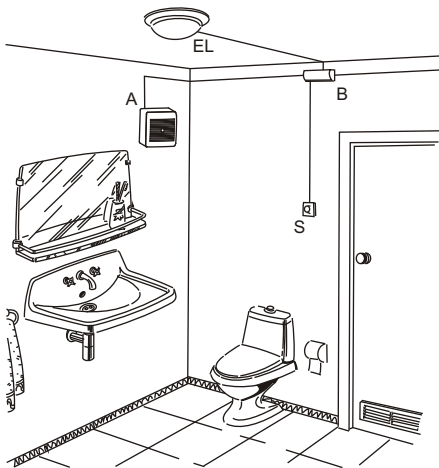

A - Fan
B - Distribution box
EL - Lighting lamp
S - External speed switch
P3-1-300 (shown schematically).

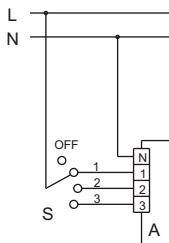

The fan is set to one of the three speeds as necessary or switched off manually with the help of external switch S (e.g. P3-1-300).

Diagram 1

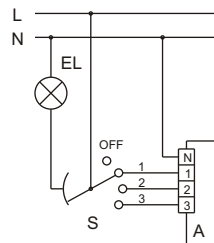

The fan is set to one of the 3 speeds with the help of the external switch S (e.g. P3-1-300).

The fan is activated or deactivated simultaneously with the light in the premises.

The fan is activated / deactivated only simultaneously with the lights.

Diagram 2

Sample schematic of basic two-speed fan model connection - modifications **A, B** and **D**.

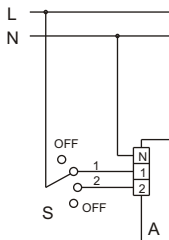
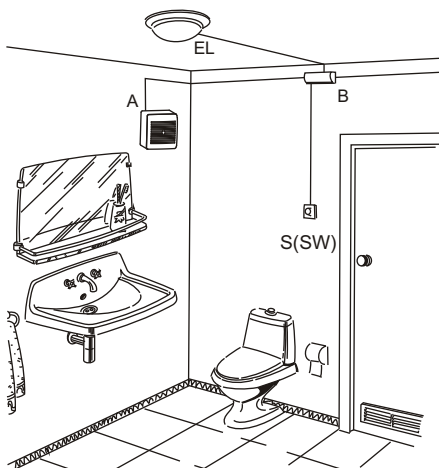

The fan is set to one of the 2 speeds as required with the help of external switch S (e.g. P2-1-300) or switched off.

Diagram 3

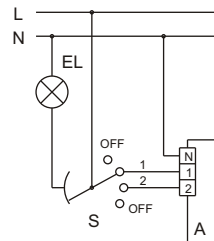

The fan is set to one of the 2 speeds with the help of external switch S (e.g. P2-1-300). The fan is activated or deactivated simultaneously with the lights on the premises. The fan is activated / deactivated only simultaneously with the lights.

Diagram 4

A - Fan
 B - Distribution box
 EL - Lighting lamp
 SW - two-position switch
 (shown schematically).
 S - External speed switch P2-1-300
 (shown schematically).

Sample schematic of basic two-speed fan model connection - modifications **A**, **B** and **D**.

CONTINUED.

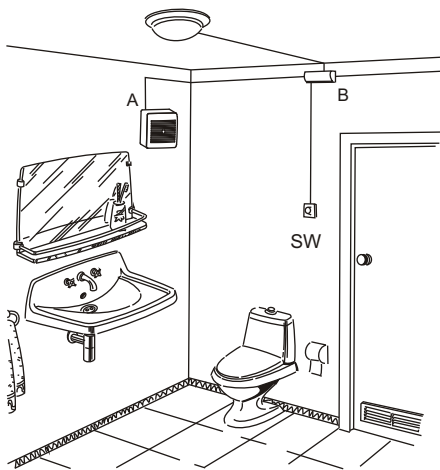

A - Fan
 B - Distribution box
 SW - two-position switch
 (shown schematically).

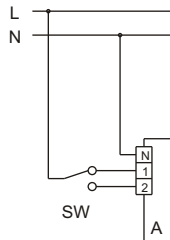

The fan constantly remains on operating at speed 1 or speed 2. The speed is selected with the help of switch SW.

Diagram 5

Sample schematic of basic two-speed fan model connection (modifications **A**, **B** and **D**) with a timer (**T**), adjustable timer (**TR**) or interval switch (**I**).

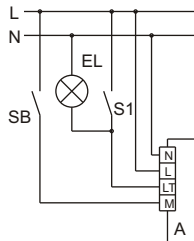
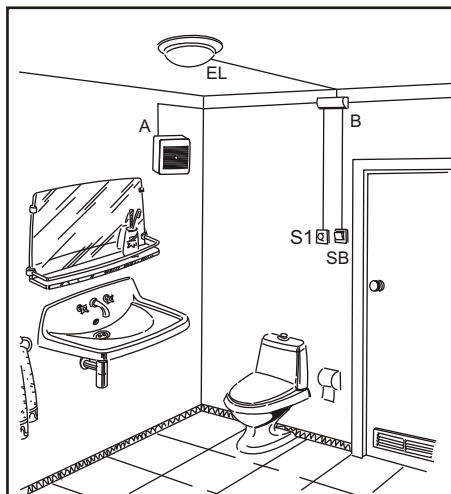

With a timer (T) or adjustable timer (TR):

If supplied with **T** and **TR** options the fan is constantly on operating at speed 1 with **SB** switch closed or constantly off with the switch open.

You can set the fan to speed 2 manually using switch **S1** which also doubles as the light switch.

In this case the delay of switching to speed 2 is 50 seconds (option **T**) or from 0 to 150 seconds (option **TR**).

On opening switch **S1** the illumination on the premises is switched off whereas the fan continues to operate according to the timer setting: for 6 minutes (**T**) or for an interval from 2 to 30 minutes (**TR**) and then automatically switches to speed 1 or switches off.

With interval switch (I):

The fan equipped with an interval switch (**I**) constantly operates at speed 1 with switch **SB** closed or remains off with the switch open.

Within the time interval manually set from 0.5 to 15 hours the fan automatically switches to speed 2.

Speed 2 is engaged for 10 minutes.

Switch **S1** used for switching the fan to speed 2 also doubles as lighting switch. The fan switches to speed 2 on elapsing of 50 second delay set on the timer.

On opening of switch **S1** the lights on the premises switch off whereas the fan reverts to the interval operation mode.

- A - Fan
- B - Distribution box
- EL - Lighting lamp
- S1 - lighting switch (shown schematically).
- SB - base load mode switch (shown schematically).

Diagram 6

Sample schematic of basic two-speed fan model connection (modifications **A**, **B** and **D**) with photoelectronic sensors (**F**).

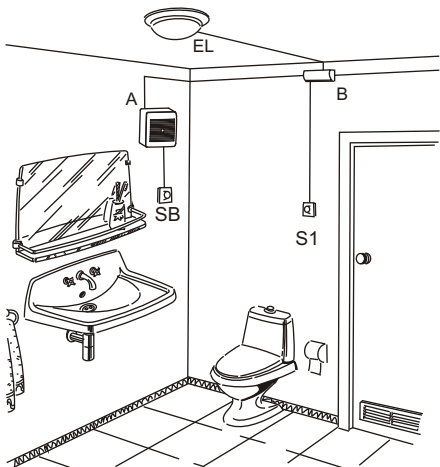

A - Fan
 B - Distribution box
 EL - Lighting lamp
 S1 - lighting switch
 (shown schematically)
 SB - base load mode switch
 (shown schematically).

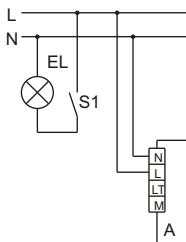

The fan initial state is off.
 On switching the lights on the photoelectronic sensor sets the fan to speed 2 on elapsing the 50 second activation delay interval set on the timer.
 On switching the lights off the fan continues to operate until elapsing of the timer setting which may range from 2 to 30 minutes and then switches off automatically (speed 1 is not used in this operation pattern).

Diagram 7

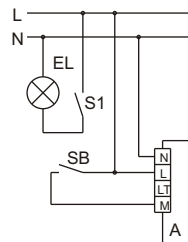

The fan constantly operates at speed 1 with switch SB closed or remains off with the switch open.
 On switching the lights on the photoelectronic sensor sets the fan to speed 2 on elapsing of the 50 second activation delay set on the timer.
 On switching the lights off the fan continues to operate until elapsing of the timer setting which may range from 2 to 30 minutes and then automatically switches to speed 1 or switches off.

Diagram 8

Sample schematic of basic two-speed fan model connection (modifications **A**, **B** and **D**) with a humidity sensor (**H**).

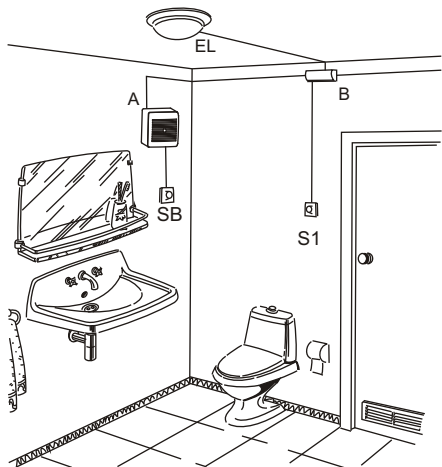

A - Fan
 B - Distribution box
 EL - Lighting lamp
 S1 - lighting switch
 (shown schematically)
 SB - base load mode switch
 (shown schematically).

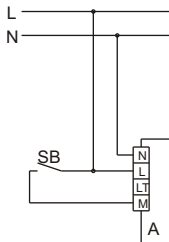

The fan operates at speed 1 with switch SB closed or remains off with the switch open.

As the relative humidity on the premises increases the fan automatically switches to speed 2 and maintains it until humidity drops to the pre-set level.

Diagram 9

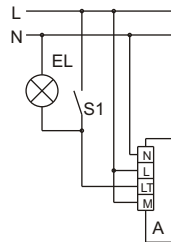

The fan constantly operates at speed 1. As the relative humidity on the premises increases the fan automatically switches to speed 2 and maintains it until humidity drops to the pre-set level. You may use switch S1 which also doubles as the light switch to manually engage speed 2.

In this case speed 2 turn-on delay is 50 seconds. The turn-off delay following the switch opening may range from 2 to 30 minutes.

Diagram 10

Sample schematic of basic two-speed fan model connection (modifications **A**, **B** and **D**) with a humidity sensor (**H**).

CONTINUED.

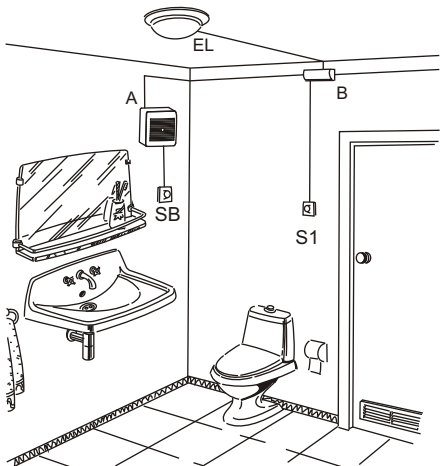

A - Fan
 B - Distribution box
 EL - Lighting lamp
 S1 - lighting switch
 (shown schematically)
 SB - base load mode switch
 (shown schematically).

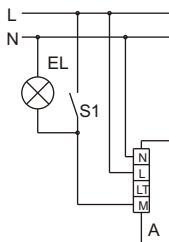

The fan constantly operates at speed 1 if the lights are switched on (using switch S1) or remains off if the lights are off.

As the relative humidity on the premises increases the fan automatically switches to speed 2 and maintains it until humidity drops to the pre-set level irrespective of switch S1 position.

Diagram 11

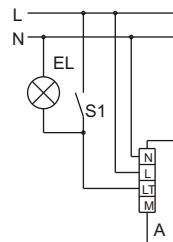

The fan initial state is off.

As the relative humidity on the premises increases the fan automatically switches to speed 2 and maintains it until humidity drops to the pre-set level.

You may use switch S1 which also doubles as the light switch to manually engage speed 2.

In this case speed 2 turn-on delay is 50 seconds. The turn-off delay following the switch opening may range from 2 to 30 minutes (speed 1 is not used in this operation pattern).

Diagram 12

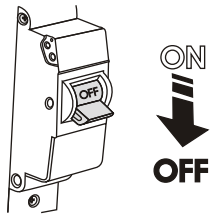
FAN
MAINTENANCE

72

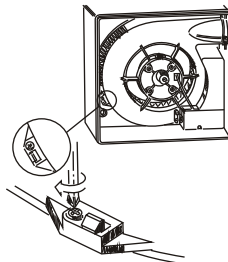

73

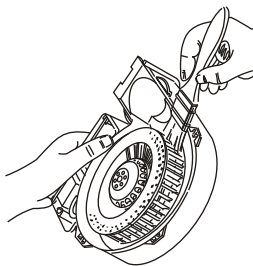

74

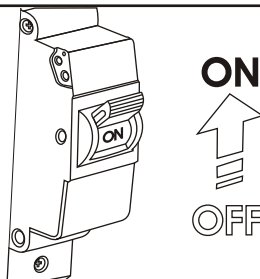

75

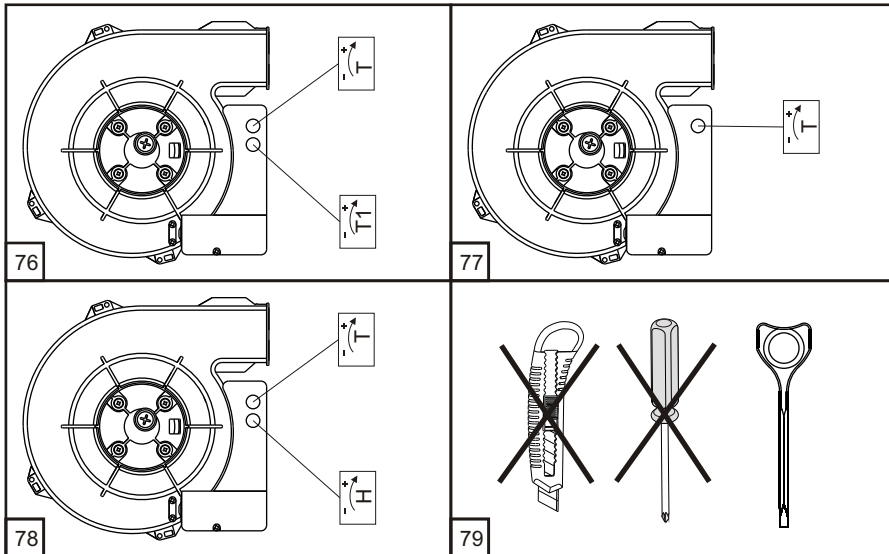
**TIMER AND
HUMIDITY
SENSOR
ADJUSTMENT**

Modification TR (Fig. 76):

T1 - turn-on delay time can be set from 0 to 150 seconds;

T - turn-off delay can be set from 2 to 30 minutes.

Modification I (Fig. 77):

T - interval timer can be set within the range from 30 minutes to 15 hours.

Modification F (Fig. 77):

T - turn-off delay can be set from 2 to 30 minutes.

Modification H (Fig. 78):

T - turn-off delay can be set from 2 to 30 minutes.

H - humidity sensor threshold can be set within the range from 60% to 90%.

**The MANUFACTURER shall not be liable for any damage resulting from any misuse of or gross mechanic interference with the fan.
The fan owner must follow the applicable instructions.**



**ACCEPTANCE
CERTIFICATE**

VN	<input type="checkbox"/>	V	<input type="checkbox"/>	1	<input type="checkbox"/>	A	<input type="checkbox"/>	KV	<input type="checkbox"/>	I	<input type="checkbox"/>
				2	<input type="checkbox"/>	B	<input type="checkbox"/>	80	<input type="checkbox"/>	L	<input type="checkbox"/>
						C	<input type="checkbox"/>			P	<input type="checkbox"/>
						D	<input type="checkbox"/>			D	<input type="checkbox"/>
										T	<input type="checkbox"/>
										TR	<input type="checkbox"/>

Plastic casing KV 80
 Fire-preventing casing KP 80
 Plastic casing with a fire damper KVK 80

(mark as necessary)

We hereby declare that the following product complies with the essential protection requirements of Electromagnetic Council Directive 2004/108/EC, 89/336/EEC and Low Voltage Directive 2006/95/EC, 73/23/EEC and CE-marking Directive 93/68/EEC on the approximation of the laws of the Member States relating to electromagnetic compatibility. This certificate is issued following test carried out on samples of the product referred to above. Assessment of compliance of the product with the requirements relating to electromagnetic compatibility was based on the following standards.

Acceptance Inspector's Stamp

Sold by
Retailer's name and shop stamp

Manufacturing Date

Sale Date

